

N10-3S

カバを外した状態

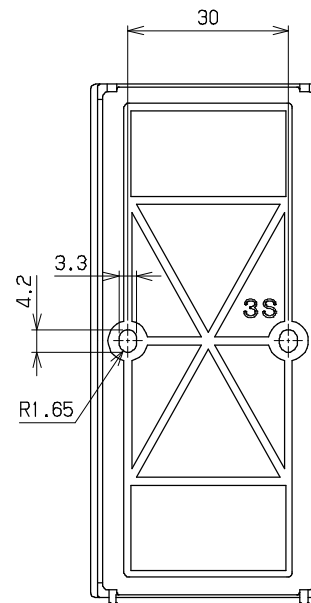

示名条片

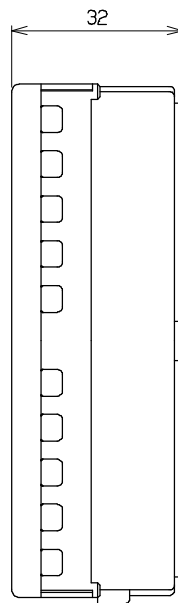
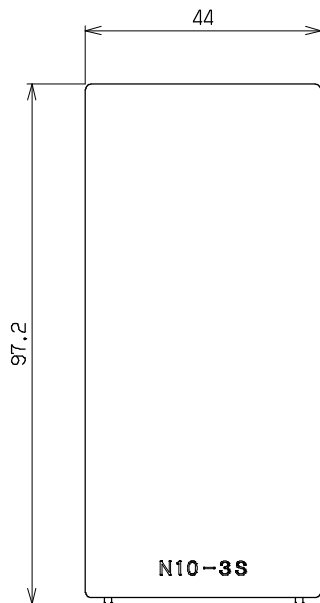
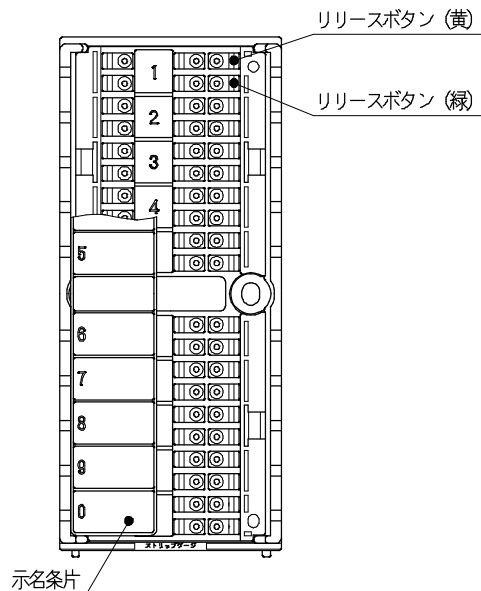
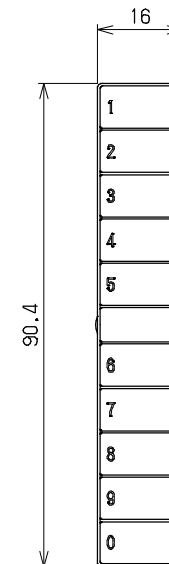

内部接続

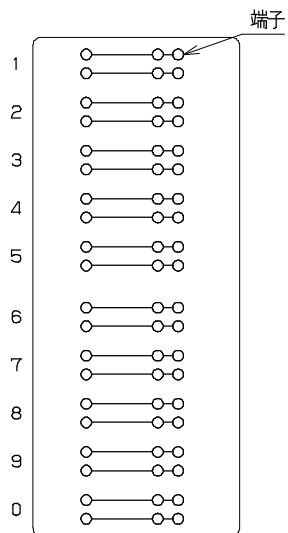

端子

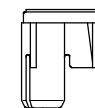
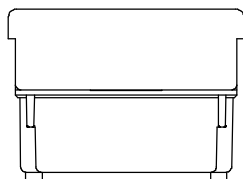

添付ねじ (丸木ねじ3.1×20)

